

Product Introduction

1. Type: HM-2×6A

2. Outline Drawing and Dimensions: (mm)

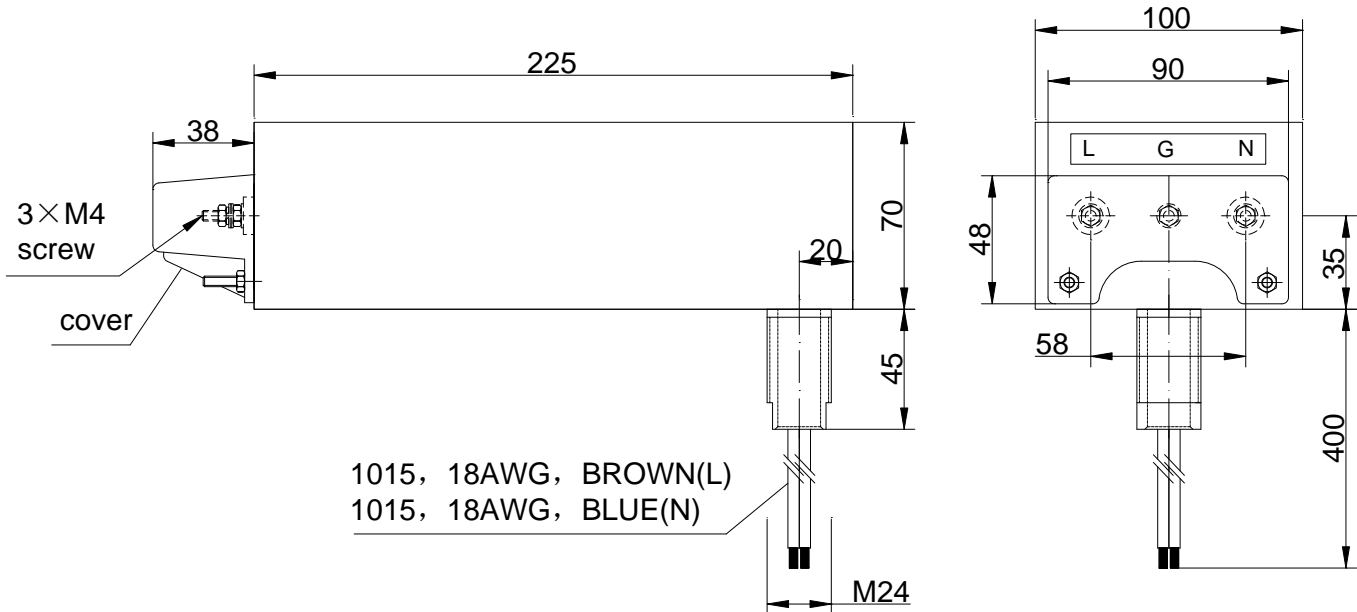

3. Technical Data:

① Rated Voltage: 250VAC/500VDC

② Operating Frequency: DC~60Hz

③ Rated current: 6A

④ Insertion Loss: ≥ 100 dB, 1MHz~10GHz

⑤ Leakage current: < 5 mA

⑥ Climatic Category: 25/085/21

4. Assembly Parts: ① M24 Conduit Screw: 1pc

② Gasket 24: 1pc

③ M24 Screw Nut: 1pc

④ EMI Gasket: 1pc

⑤ Certificate: 1pc

5. Installation Sketch:

