

HM-EMP-60A-CM 规格书 (交流电源滤波器)

◆ 技术参数 Specification

额定电压 Rated voltage	230VAC
工作频率 Operating frequency	50/60Hz
额定电流 Rated current	60A
气候类别 Climatic category	10/070/21
试验电压 Test voltage (2s/1Min)	

线—线 Line-to-line: 1414VDC

线—壳 Line-to-case: 1414VDC

典型插入损耗 Typical insertion loss

Frequency	14K-18GHz
CM Insert Lossing	100dB

◆ 浪涌抑制性能 Transient Suppression Performance

Accord with MIL-STD-188-125-1 &-2

◆ 外形尺寸 Dimension

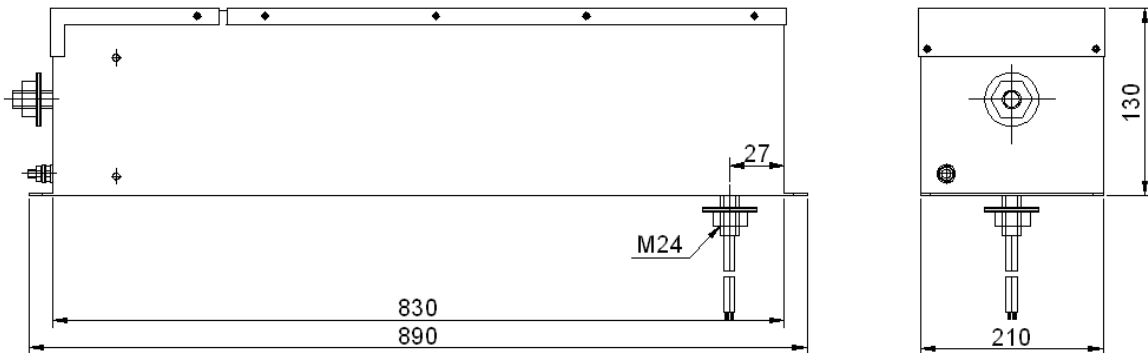

◆ 电性能 Electrical characteristics

特点与应用 Features & Applications

工作频带宽，插入损耗高: Wide operating band, high insert loss

干扰抑制能力强: Strong ability for restrain interference

低压降，低漏电流: Low voltage drop, low leakage current

用于电磁屏蔽房、屏蔽柜、电子方舱、信息安全保密房、医院 CT、核磁共振房、可控硅变流设备、电源净化设备的电源端的滤波 Use for filter in electro-magnetic mask room、mask cabinet、electronic、square cabin、information security room 、CT equipment of hospital、nuclear-magnetic、resonance room、SCR current converting equipment、power terminal of the equipment for power purification.